

TANGRAM – TRACE 74280

PROJECT PROJÉT
SPEC TYPE
NOTES

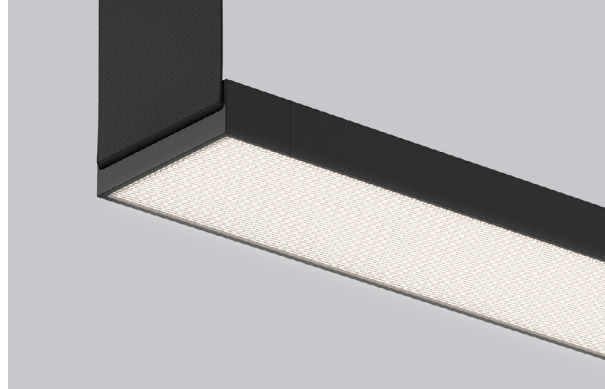

FINISH FINI

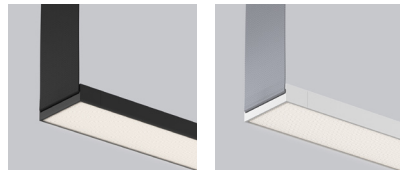

BLKE

WHE

STRAP FINISH FINI DE LA STRAP

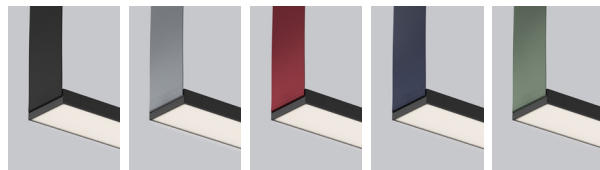

BLKE

SGS

PNS

OBS

BGS

WIDTH & OVERALL HEIGHT REFERENCE

RÉFÉRENCE POUR LA LARGEUR ET LA HAUTEUR HORS-TOUT

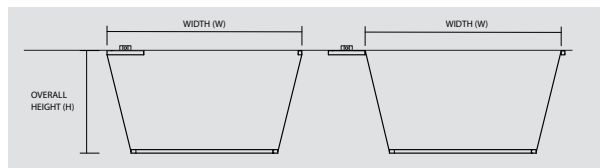

MOUNTING OPTIONS OPTIONS DE MONTAGE

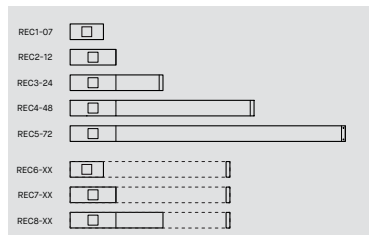

PRODUCT CHARACTERISTICS CARACTÉRISTIQUES DU PRODUIT



3.5"
(89mm)
x 3.5"
(89mm)

ORDERING SPECIFICATION SPÉCIFICATION DE COMMANDE

CODE

MODEL MODÈLE

(WITHOUT SPACER)

74280-24 TANGRAM - TRACE 24"
74280-48 TANGRAM - TRACE 48"
74280-72 TANGRAM - TRACE 72"

(WITH SPACER, PLEASE SEE CONFIGURATION PAGE)

74280-L01 TANGRAM - TRACE 24" WITH ONE 24" SPACER
74280-L02 TANGRAM - TRACE 24" WITH TWO 24" SPACERS
74280-L03 TANGRAM - TRACE 24" WITH TWO SPACERS, ONE 24" & ONE 48"
74280-L04 TANGRAM - TRACE 48" WITH ONE 7" SPACER
74280-L05 TANGRAM - TRACE 48" WITH TWO 24" SPACERS
74280-L06 TANGRAM - TRACE 48" WITH ONE 72" SPACER
74280-L07 TANGRAM - TRACE 72" WITH ONE 24" SPACER
74280-L08 TANGRAM - TRACE 72" WITH ONE 48" SPACER
74280-L09 TANGRAM - TRACE 72" WITH ONE 72" SPACER
74280-L10* TANGRAM - TRACE, TWO 24" WITH ONE CANOPY & TWO ANCHORS
74280-L11* TANGRAM - TRACE, THREE 24" WITH TWO CANOPIES & TWO ANCHORS
74280-L12* TANGRAM - TRACE, ONE 24", ONE 48" & ONE 72", WITH TWO CANOPIES & TWO ANCHORS
* ONLY AVAILABLE WITH REC6, REC7 & REC8 MOUNTING OPTIONS

LIGHT SOURCE SOURCE LUMINEUSE

LED.LO LOW OUTPUT
LED REGULAR OUTPUT
LED.HO HIGH OUTPUT

COLOR TEMPERATURE TEMPÉRATURE DE COULEUR

27 2700K
30 3000K
35 3500K
40* 4000K
* LONGER LEAD TIME MAY APPLY. PLEASE CONTACT YOUR EUREKA REPRESENTATIVE

COLOR RENDERING INDEX (CRI) INDICE DE RENDU DE COULEUR (IRC)

90 90+ CRI

90

VOLTAGE VOLTAGE

120V 120 VOLT
277V 277 VOLT

CONTROL OPTION OPTION DE CONTRÔLE

DV 0-10V DIMMING (120V-277V)
DP PHASE DIMMING (120V ONLY) 24" (LOW, REG & HO), 48" (LOW, REG & HO), 72" (LOW)
NLTAIR2* NLIGHT AIR CONTROL GEN 2 (NOT AVAILABLE WITH REC1 & REC6 CANOPIES)
NLIGHT* NLIGHT WIRED CONTROL (NOT AVAILABLE WITH REC1 & REC6 CANOPIES)
* REQUIRES A REMOTE POWER PACK (39NLAA FOR NLTAIR2 & 39NLWA FOR NLIGHT). REFER TO NLIGHT GUIDE AND INSTALLATION SHEET FOR ALL REQUIREMENTS.

EMERGENCY BATTERY BATTERIE D'URGENCE

FOR 120-277V ONLY. EM DRIVER BOX INCLUDED, INSTALLED REMOTELY. SEE EM GUIDE FOR DETAILS

EMB* EMERGENCY BATTERY FOR REMOTE BOX
* 3981E ACCESSORY IS REQUIRED FOR THIS OPTION

MOUNTING MONTAGE

WITHOUT ANCHOR (FIXED WIDTH)

REC1-07 7" RECTANGULAR CANOPY (NOT AVAILABLE WITH 74280-72 REG & HO)
REC2-12 12" RECTANGULAR CANOPY
REC3-24 24" RECTANGULAR CANOPY
REC4-48 48" RECTANGULAR CANOPY
REC5-72 72" RECTANGULAR CANOPY

WITH ANCHOR (CUSTOM WIDTH)

REC6-XX* 7" RECTANGULAR CANOPY WITH REMOTE ANCHOR (NOT AVAILABLE WITH 74280-72 REG & HO)
REC7-XX* 12" RECTANGULAR CANOPY WITH REMOTE ANCHOR
REC8-XX* 24" RECTANGULAR CANOPY WITH REMOTE ANCHOR (ONLY FOR L10, L11 & L12 TANGRAM MODELS)
* SPECIFY DISTANCE BETWEEN STRAPS (W), AT CEILING. PLEASE REFER TO ILLUSTRATION BELOW. FOR L10, L11 & L12 MODELS, SPECIFY THE TOTAL DISTANCE.

OVERALL HEIGHT HAUTEUR HORS TOUT

XX* OVERALL HEIGHT
* SPECIFY OVERALL HEIGHT (H), FROM BOTTOM OF THE FIXTURE TO CEILING, IN INCHES.

CANOPY FINISH FINI DU PAVILLON

BLKE BLACK FINE TEXTURE
WHE WHITE FINE TEXTURE
XX* CUSTOM RAL COLOR
* SPECIFY 4 DIGIT RAL CLASSIC CODE. LONGER LEAD TIME MAY APPLY. PLEASE CONTACT YOUR EUREKA REPRESENTATIVE.

STRAP FINISH FINI DE LA STRAP

BLKE BLACK NYLON STRAP
SGS SILVERGRAY NYLON STRAP
PNS PINOT NYLON STRAP
OBS OCEAN BLUE NYLON STRAP
BGS BRITISH RACING GREEN NYLON STRAP

FIXTURE FINISH FINI DU LUMINAIRE

BLKE BLACK FINE TEXTURE
WHE WHITE FINE TEXTURE
XX* CUSTOM RAL COLOR
SPACERS WILL HAVE THE SAME FINISH AS THE FIXTURE
* SPECIFY 4 DIGIT RAL CLASSIC CODE. LONGER LEAD TIME MAY APPLY. PLEASE CONTACT YOUR EUREKA REPRESENTATIVE.

EMERGENCY BATTERY ACCESSORY ACCESSOIRE BATTERIE D'URGENCE

3981EA ELECTRICAL BOX FOR EMB EMERGENCY BATTERY
39NLAA* NLIGHT AIR GEN 2 REMOTE POWER PACK
39NLWA* NLIGHT WIRED REMOTE POWER PACK
* FOR CHICAGO PLENUM INSTALLATION. PLEASE CONTACT YOUR EUREKA REPRESENTATIVE.



SPECIFICATION

TANGRAM – TRACE 74280 - WHITE TUNING

PROJECT PROJET
SPEC TYPE
NOTES

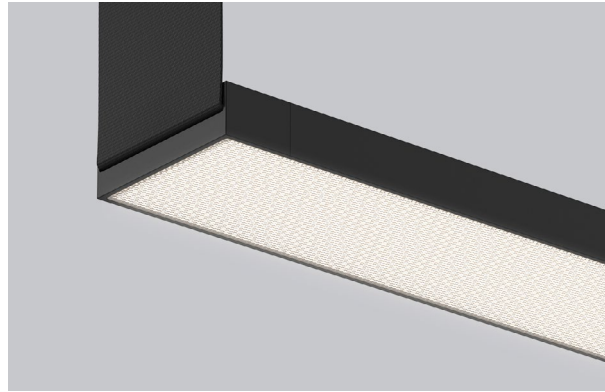

FINISH FINI

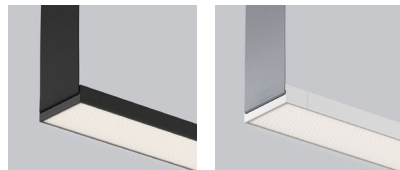

BLKE

WHE

STRAP FINISH FINI DE LA STRAP

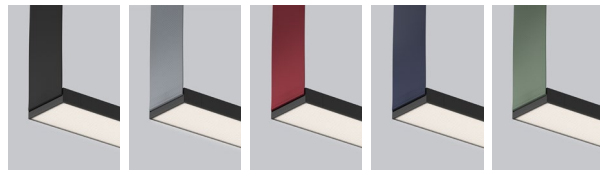

BLKS

SGS

PNS

OBS

BGS

WIDTH & OVERALL HEIGHT REFERENCE

RÉFÉRENCE POUR LA LARGEUR ET LA HAUTEUR HORS-TOUT

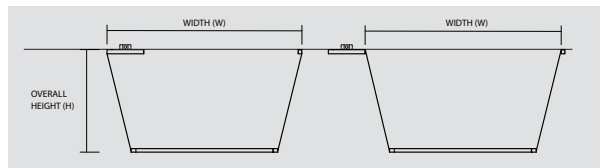

MOUNTING OPTIONS OPTIONS DE MONTAGE

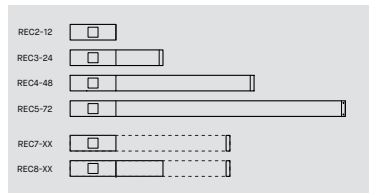

ORDERING SPECIFICATION SPÉCIFICATION DE COMMANDE

CODE

MODEL MODÈLE

(WITHOUT SPACER)

- 74280-24 TANGRAM - TRACE 24"
- 74280-48 TANGRAM - TRACE 48"
- 74280-72 TANGRAM - TRACE 72"

(WITH SPACER, PLEASE SEE CONFIGURATION PAGE)

- 74280-L01 TANGRAM - TRACE 24" WITH ONE 24" SPACER
 - 74280-L02 TANGRAM - TRACE 24" WITH TWO 24" SPACERS
 - 74280-L03 TANGRAM - TRACE 24" WITH TWO SPACERS, ONE 24" & ONE 48"
 - 74280-L04 TANGRAM - TRACE 48" WITH ONE 7" SPACER
 - 74280-L05 TANGRAM - TRACE 48" WITH TWO 24" SPACERS
 - 74280-L06 TANGRAM - TRACE 48" WITH ONE 72" SPACER
 - 74280-L07 TANGRAM - TRACE 72" WITH ONE 24" SPACER
 - 74280-L08 TANGRAM - TRACE 72" WITH ONE 48" SPACER
 - 74280-L09 TANGRAM - TRACE 72" WITH ONE 72" SPACER
 - 74280-L10* TANGRAM - TRACE, TWO 24" WITH ONE CANOPY & TWO ANCHORS
 - 74280-L11* TANGRAM - TRACE, THREE 24" WITH TWO CANOPIES & TWO ANCHORS
 - 74280-L12* TANGRAM - TRACE, ONE 24", ONE 48" & ONE 72", WITH TWO CANOPIES & TWO ANCHORS
- * ONLY AVAILABLE WITH REC7 & REC8 MOUNTING OPTIONS

LIGHT SOURCE SOURCE LUMINEUSE

LED REGULAR OUTPUT

COLOR TEMPERATURE TEMPÉRATURE DE COULEUR

TW* TUNABLE WHITE (2700K TO 5000K)
* LONGER LEAD TIME MAY APPLY, PLEASE CONTACT YOUR EUREKA REPRESENTATIVE

COLOR RENDERING INDEX (CRI) INDICE DE RENDU DE COULEUR (IRC)

80 80+ CRI

VOLTAGE VOLTAGE

120V 120 VOLT
277V 277 VOLT

CONTROL OPTION OPTION DE CONTRÔLE

DDV DUAL 0-10V DIMMING
NTL NLIGHT NTUNE CONTROL

MOUNTING MONTAGE

WITHOUT ANCHOR (FIXED WIDTH)

- REC2-12 12" RECTANGULAR CANOPY
- REC3-24 24" RECTANGULAR CANOPY
- REC4-48 48" RECTANGULAR CANOPY
- REC5-72 72" RECTANGULAR CANOPY

WITH ANCHOR (CUSTOM WIDTH)

- REC7-XX* 12" RECTANGULAR CANOPY WITH REMOTE ANCHOR
 - REC8-XX* 24" RECTANGULAR CANOPY WITH REMOTE ANCHOR (ONLY FOR L10, L11 & L12 TANGRAM MODELS)
- * SPECIFY DISTANCE BETWEEN STRAPS (W), AT CEILING. PLEASE REFER TO ILLUSTRATION BELOW. FOR L10, L11 & L12 MODELS, SPECIFY THE TOTAL DISTANCE.

OVERALL HEIGHT HAUTEUR HORS TOUT

XX* OVERALL HEIGHT
* SPECIFY OVERALL HEIGHT (H), FROM BOTTOM OF THE FIXTURE TO CEILING, IN INCHES.

CANOPY FINISH FINI DU PAVILLON

- BLKE BLACK FINE TEXTURE
 - WHE WHITE FINE TEXTURE
 - XX* CUSTOM RAL COLOR
- * SPECIFY 4 DIGIT RAL CLASSIC CODE. LONGER LEAD TIME MAY APPLY, PLEASE CONTACT YOUR EUREKA REPRESENTATIVE.

STRAP FINISH FINI DE LA SANGLE

- BLKS BLACK STRAP
- SGS SILVERGRAY STRAP
- PNS PINOT STRAP
- OBS OCEAN BLUE STRAP
- BGS BRITISH RACING GREEN STRAP

FIXTURE FINISH FINI DU LUMINAIRE

- BLKE BLACK FINE TEXTURE
 - WHE WHITE FINE TEXTURE
 - XX* CUSTOM RAL COLOR
- SPACERS WILL HAVE THE SAME FINISH AS THE FIXTURE
* SPECIFY 4 DIGIT RAL CLASSIC CODE. LONGER LEAD TIME MAY APPLY, PLEASE CONTACT YOUR EUREKA REPRESENTATIVE.

PRODUCT CHARACTERISTICS CARACTÉRISTIQUES DU PRODUIT

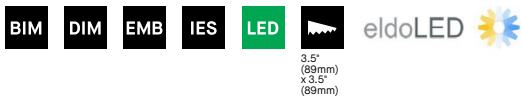

3.5"
(89mm)
x 3.5"
(89mm)

TANGRAM – TRACE 74280

ALL CONFIGURATIONS BELOW ARE SHOWN WITH AN 60" OVERALL HEIGHT.



74280-L01
24" FIXTURE. ONE 24" SPACER AT THE FIRST THIRD OF THE TOTAL HEIGHT.
SHOWN WITH A REC3-24 CANOPY.

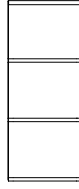

74280-L02
24" FIXTURE. TWO 24" SPACERS AT EACH THIRD OF THE TOTAL HEIGHT.
SHOWN WITH A REC3-24 CANOPY.

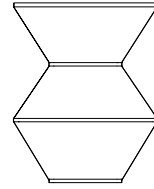

74280-L03
24" FIXTURE. ONE 48" SPACER AT THE FIRST THIRD AND ONE 24" SPACER AT THE SECOND THIRD.
SHOWN WITH A REC4-48 CANOPY.

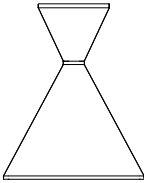

74280-L04
48" FIXTURE. ONE 7" SPACER AT THE SECOND THIRD OF THE TOTAL HEIGHT.
SHOWN WITH A REC3-24 CANOPY.

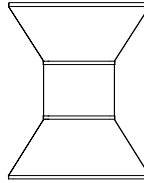

74280-L05
48" FIXTURE. TWO 24" SPACERS AT EACH THIRD OF THE TOTAL HEIGHT.
SHOWN WITH A REC4-48 CANOPY.

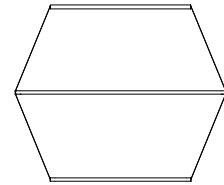

74280-L06
48" FIXTURE. ONE 72" SPACER AT THE MIDDLE OF THE TOTAL HEIGHT.
SHOWN WITH A REC4-48 CANOPY.

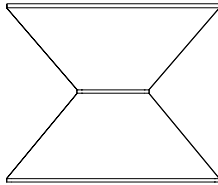

74280-L07
72" FIXTURE. ONE 24" SPACER AT THE MIDDLE OF THE TOTAL HEIGHT.
SHOWN WITH A REC5-72 CANOPY.

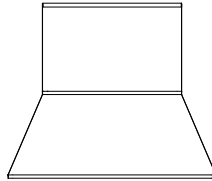

74280-L08
72" FIXTURE. ONE 48" SPACER AT THE MIDDLE OF THE TOTAL HEIGHT.
SHOWN WITH A REC3-24 CANOPY.

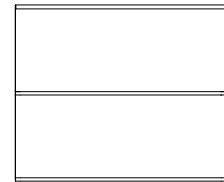

74280-L09
72" FIXTURE. ONE 72" SPACER AT THE MIDDLE OF THE TOTAL HEIGHT.
SHOWN WITH A REC5-72 CANOPY.

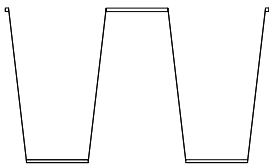

74280-L10
24" FIXTURES WITH TWO ANCHORS.
SHOWN WITH THE REC8 CANOPY OPTION AND A 108" TOTAL WIDTH.

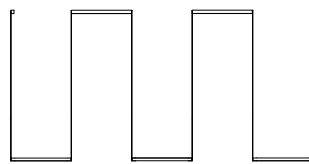

74280-L11
24" FIXTURES.
SHOWN WITH THE REC8 CANOPY OPTION AND A 120" TOTAL WIDTH.

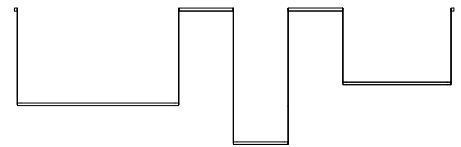

74280-L12
ONE 24" FIXTURE, ONE 48" FIXTURE AT THE MIDDLE OF THE TOTAL HEIGHT AND ONE 72" FIXTURE AT THE FIRST THIRD OF THE TOTAL HEIGHT.
SHOWN WITH THE REC8 CANOPY OPTION AND A 192" TOTAL WIDTH.

CUSTOM CONFIGURATIONS

FOR CUSTOM CONFIGURATIONS, SIMPLY CONTACT THE FACTORY AND WE WILL BE PLEASED TO DISCUSS YOUR DESIGN REQUIREMENTS.

TANGRAM TRACE - 74280

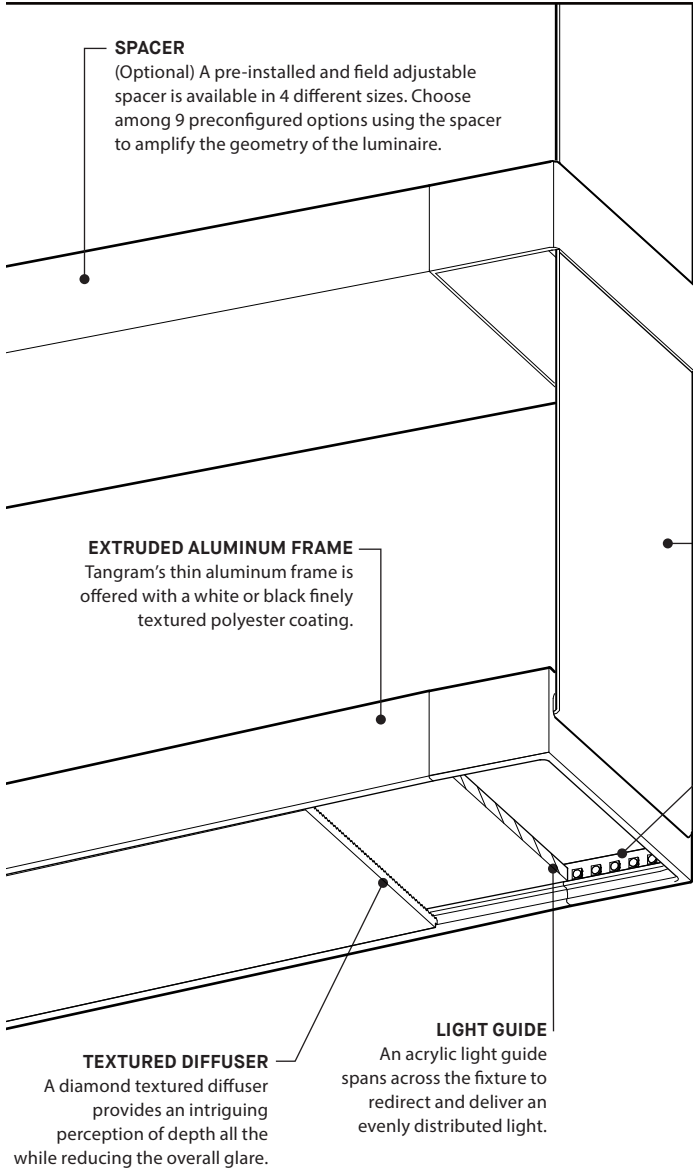

CUSTOM WIDTH

Canopy and anchor distance can be specified to create a variety of strap angles. They can be positioned inside or outside as desired.

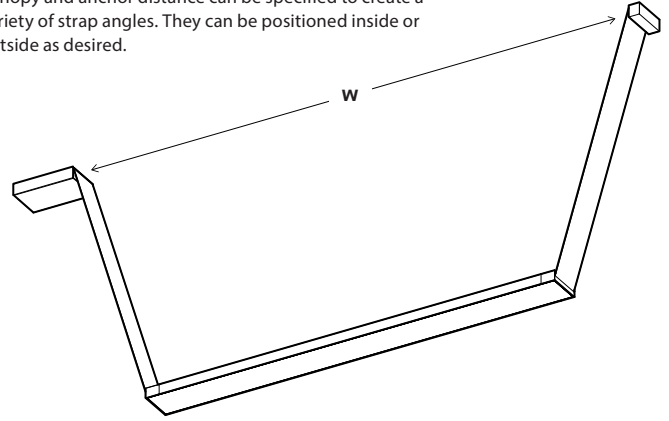

STRAP SUSPENSION

Fixture is suspended by two high quality UV resistant straps housing an imperceptible flat power cable. Available in 5 eye-catching colors.

HIGH QUALITY LED

A single high rendering quality LED strip illuminates Tangram's edge lit surface. Also available in tunable white.

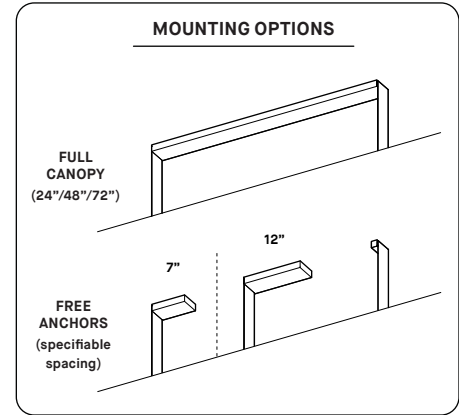

LIGHT SOURCE SIZES

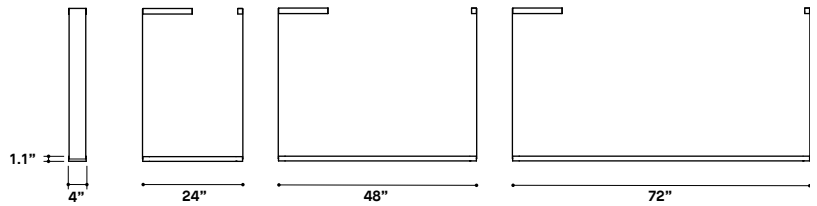

PRODUCT SPECIFICATION	74280-24				74280-48				74280-72			
	LOW	REG	HO	TW	LOW	REG	HO	TW	LOW	REG	HO	TW
PERFORMANCE												
SYSTEM WATTAGE	13,5 W	17,7 W	22,1 W	15,6 W	27,1 W	35,5 W	44,2 W	31,2 W	40,6 W	53,2 W	66,2 W	46,8 W
DELIVERED LUMENS (4000K - WHE)	1339 LM	1701 LM	2053 LM	1521 LM	2679 LM	3402 LM	4107 LM	3042 LM	4018 LM	5102 LM	6160 LM	4564 LM
DELIVERED LUMENS/FEET (4000K - WHE)	683 LM/FT	867 LM/FT	1046 LM/FT	775 LM/FT	683 LM/FT	867 LM/FT	1046 LM/FT	775 LM/FT	683 LM/FT	867 LM/FT	1046 LM/FT	775 LM/FT
EFFICACY	99 LM/W	96 LM/W	93 LM/W	97 LM/W	99 LM/W	96 LM/W	93 LM/W	97 LM/W	99 LM/W	96 LM/W	93 LM/W	97 LM/W
OTHER INFORMATION												
LUMINAIRE'S WEIGHT	3 LBS / 1,4 KG				6 LBS / 2,8 KG				9 LBS / 4,2 KG			
L70 (LUMEN MAINTENANCE) LO/REG/HO	> 60 000 HRS				> 60 000 HRS				> 60 000 HRS			

EFFICACY MULTIPLIERS

CCT	FACTOR	TW FACTOR
5000K	-	0.93
4000K	1.00	1.00
3500K	0.97	0.99
3000K	0.93	0.98
2700K	0.89	0.91

LIGHT DISTRIBUTION

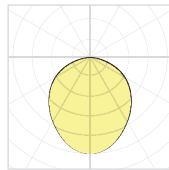

74280



Visit our website for warranty terms and conditions.



TECHNICAL DATA

TANGRAM TRACE - 74280

CONFIGURATION GUIDE

STEP 1 - CHOOSE YOUR FIXTURE

Choose among a variety of 9 preconfigurations. Refer to specification sheet to view all available options.



74280-24

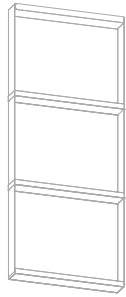

74280-L02

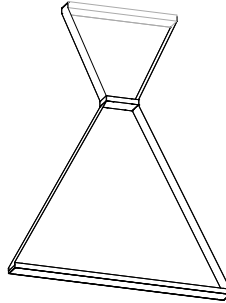

74280-L04

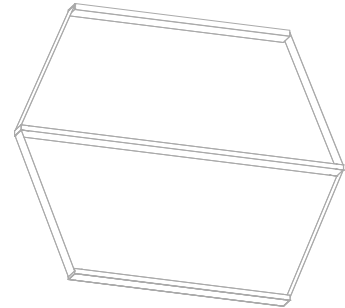

74280-L06



STEP 2 - CHOOSE YOUR MOUNTING OPTION AND OVERALL WIDTH (W)

Change the look of your fixture by selecting a different mounting option and customizing the width between the anchors for distinct strap angles.

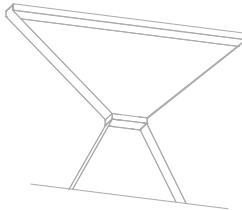
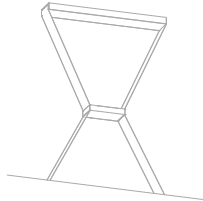
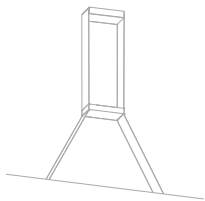

FULL LENGTH CANOPY
FIXED WIDTH

OR

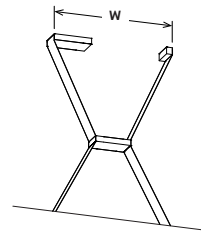

W = 24"

CANOPY WITH ANCHOR
SPECIFY OVERALL WIDTH (W)

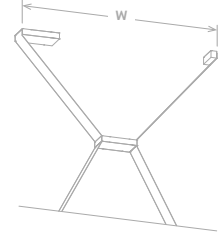

STEP 3 - SPECIFY OVERALL HEIGHT

Specify the overall height from the bottom of the fixture to the ceiling preserving the same component height proportions.

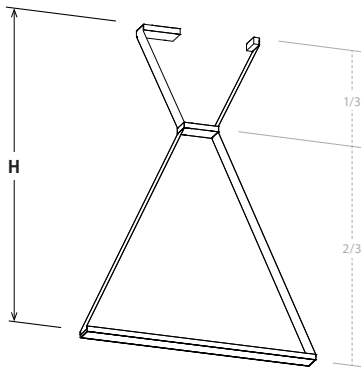
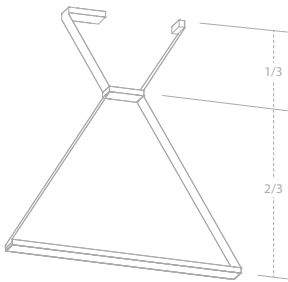

H = 66"

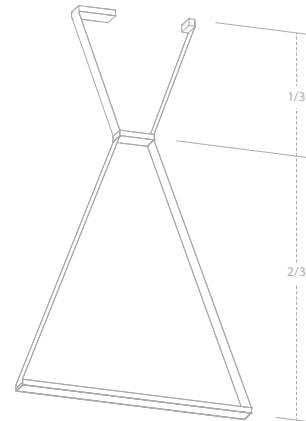

Strap Material Color Options



Eureka Code	BGS British Racing Green	BLKS Black	OBS Ocean Blue	PNS Pinot	SGS Silver Gray
Pantone Color Match	17-6212	Standard Black	19-4029	19-1930	20-0009
SUGGESTED COMBINATIONS					
Eureka Finish Combo	PGE*	BLKE	NBE	N/A	LGE*
RAL K7 Combo	6011*	9004	5003	3011*	7046*
Eureka Felt Combo	DTF Deep Teal Green*	BBF Black	OBF Ocean Blue	PNF Pinot Noir	TGF Titanium Gray

*Tone-on-tone combo

- Colors shown for visual reference only. To visualize finishes properly, use appropriate Pantone color chart, RAL color chart or felt samples.
- Due to the dye process, colors may vary slightly from batch to batch.
- Consult your sales representative or factory to get a sample.